

AKRIL | AKRIL SELECT

—  
SPLASHBACKS FOR KITCHEN,  
BATHROOM & LAUNDRY



# Installation Instructions

Manufactured in Australia by:



1/37 Hosie Street, Bayswater VIC AUS 3153  
Telephone: (613) 9729 4999  
Facsimile: (613) 9729 5197  
Email: cme@composite.com.au



## Tools to Assist with Installation

Marker	Trestle Table or Work Bench
Straight Edge	Sanding Block
Tape Measure	Wet and dry sand papers
Carpenters Square	Neutral cure translucent silicone
Caulking Gun	Double Sided tape
Circular Saw	3mm Tile Spacers
Drill	Appropriate task related PPE (Personal Protective Equipment)

## Warnings

Akril is not to be used in direct contact with any heat source above 80° C.  
— See *heat tolerance section for additional advice.*

Please inspect every sheet of Akril before installation for any imperfections or colour batch issues as these will not be covered under warranty after installation.

Ensure Painted side is installed against the wall.

When installed with the Akril glass filler panel or Stainless Steel filler panel Akril Polymers are suitable for use in a kitchen with a gas cook top. ask your sales person about these items.

Do not use a knife to open the carton your Akril panel comes in as you can damage your panel with cutting implements when opening.

Akril is for use as an internal decorative panel only and not suitable for use outdoors.

Your Akril panel will expand and contract with temperature fluctuations, always ensure expansions gaps are allowed around the perimeter of each panel.

Akril panels must always be stored inside and lied flat to prevent any potential bowing of the sheet.

## Technical Support

It is not practical to describe every possible application for Akril in this document.

This document is a guideline for installing Akril and will not wear any liability for waterproofing which should be installed to the current Australian Standard.

For technical help please contact Akril on 1800 46 47 28.

# An Introduction to Akril

**Akril is an Australian made high gloss decorative panel system. Akril can be used in all areas across your home—kitchens, bathrooms, laundries—*almost any vertical surface!***

## Area Preparation

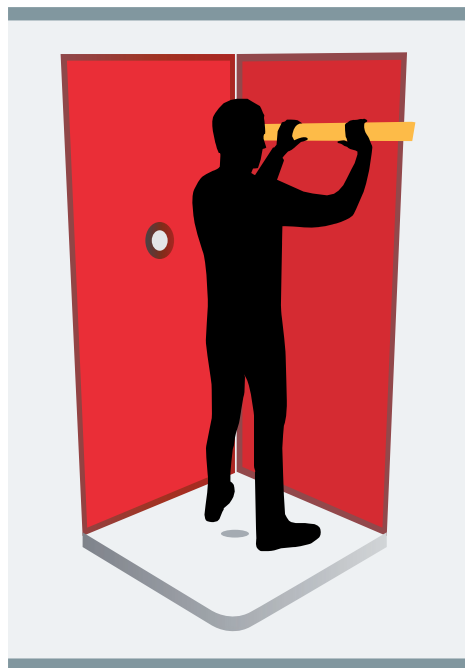

Hint—  
Use a straight edge to press Akril  
onto the wall to ensure a flat finish

Always ensure your walls are clean, dry, smooth and free from any foreign materials.

Ensure any fixings used to hold the backing substrate that is behind your Akril panel are recessed or flush to prevent damage to your colour back by screw heads or nails etc.

All backing substrates should be flush with no lipping or steps across different sheets.

Where you are installing your Akril panel over existing tiles ensure they are structurally sound with no loose tiles. Where you have loose tiles remove completely and fill void with an appropriate filler. Clean all tiles thoroughly with a grease removing cleaner like sugar soap to remove any contaminants. Extremely high gloss tiles may need to be scuffed with coarse sandpaper to ensure correct adhesion with your silicone (see silicone manufacturers recommendations).

**Tip:**

A suggestion is when installing multiple panels determine where your joins will be and identify the area that may be visible between these joins with your marker. A good idea is to paint the back wall with a similar colour paint as to your Akril panel to help reduce the visibility of your join.

## Handy Hints

Once you have completed all preparation and cutting don't forget to remove the protective film on the back (painted) side of your panel before adhering to your wall

Always leave the front protective film on the front of your panel until the very last. This should be the last job after you have cleaned up your construction site.

When pushing your panel against a wall use a straight edge as this will ensure you have a nice flat installation rather than one that follows the contour of an uneven wall.

Use the packaging your panel came in to make up a template for cutting your sheet.

Use tile spacers to give you the correct spacing between sheets and your bench top

Masking tape on the painted back of your sheet where a hole is to be drilled can help prevent starring and damaging the paint.

When cutting your Akril panel always cut through into a sacrificial board as this will help prevent vibration and chatter when cutting.

You can use small pieces of double sided tape to hold your panel in place while your silicone cures.

# Akril Kitchen Splashbacks

## Heat Tolerance

### Induction

Figure 1

Akril can be used directly behind induction cook tops, reducing time and hassles associated with colour back glass.

### Electric | Ceramic Cooktops

Figure 1

Akril can be used directly behind electric and ceramic cook tops when covered with cookware. An exposed cook top emits far greater radiant heat than when covered and this can damage your splashback. Therefore Akрил is only covered under warranty against normal wear and tear.

### Heat tolerance

Figure 2

Do not leave your hot plate unattended. Radiant heat will damage your Akрил splashback and will void warranty.

### Gas Cooktops

Figure 3

Akril must be used behind gas cooktops in conjunction with a non combustible materials such as glass, tiles or stainless steel.

Akril requires a minimum 150mm up stand behind the gas cooktop to comply with Australian standards. Akрил can be used above the 150mm non-combustible up stand. Alternatively stainless steel, glass or tiles can run all the way to the range hood.

### Expansion

Figure 3

A 3mm expansion gap is required between your Akрил polymer panel & any adjoining substrate. i.e. benchtop, glass filler panel, wall, additional polymer panels.

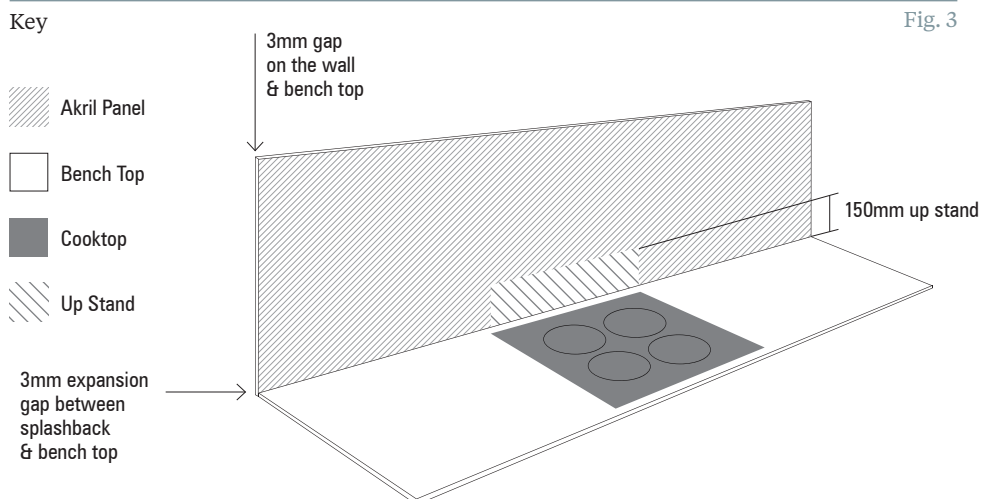
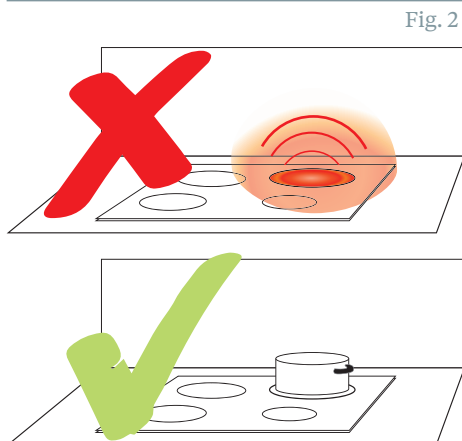
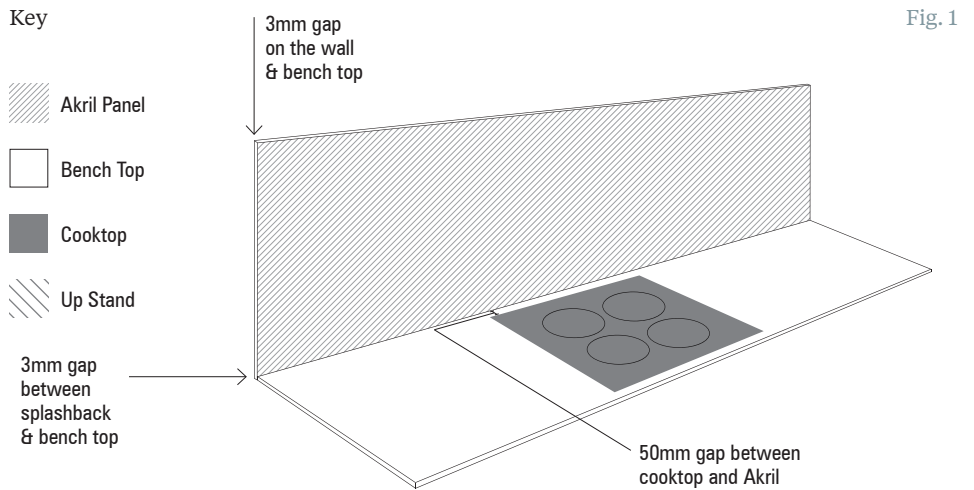

# Cutting Your Akril Panel

## Circular Saw

Always cut Akril on a flat secured surface. (Figure 5)

With quality equipment, an excellent edge finish can be achieved with Akril. The main factors in achieving the best possible outcome with a circular saw are:

**Panel rigidity.** Clamp the sheet on both sides of the cut.

**Saw stability.** Always use a good quality fence or guide to improve saw stability and straight-line cutting.

**Saw bearing quality.** The price of a circular saw can be a good indication of the quality of the bearings used inside. Cheaper saws often use bushes that offer little to limit the blade's sideways float, and will begin to wear quickly. This will have a dramatic impact on cut quality.

**Blade selection.** Always use a blade with the correct cutting geometry. Aluminum blades generally work well with Akril.

Reduce the cutting depth to allow the blade to cut approximately 7mm through the Akril, preferably cutting into a sacrificial MDF board or similar.

## Circular Blade Geometry and Conditions

### Circular Blades for Akril.

Akril is best cut using fine-tooth Aluminum circular blades with either a "hollow ground" geometry or a "triple chip" blade with the following geometry and conditions;

Acrylic cutting blades are also suitable although at times are harder to source.

Blade Diameter (mm)	255–305
Number of Teeth	80–100
Tooth Thickness (mm)	3–3.5
Clearance Angle	15–20°
Cutting Angle (Rake)	-5°
Cutting Angle of Setting Band	2–3°
Blade Speed (rpm)	3k–5k
Surface Speed (m/min)	3k–4k

## Cutting of Penetrations

When measuring and marking for cut-outs around power outlet boxes etc, ensure enough clearance is given for the switch body and that the cover plates or bulkhead fittings will cover the finished cut-outs.

Always drill the corners for any cut out. It is imperative you have rounded internal corners for any cut out to prevent fracture or cracking.

Use an approved sealer to seal the edge and a 50mm perimeter of the painted side of any Cut Outs.

Fig. 4.1. Sutton Multi purpose drill bit shown.  
Fig. 4.2. Blunt tip std drill bit shown.

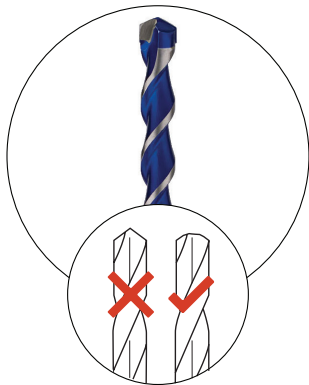

Fig. 4

Fig. 4.1

Fig. 4.2

## Hole Saws

Hole saws should be sharp, but the pilot drill blunt. It is recommended to drill the hole saw half way through, then turn the Akril over and finish the hole.

This prevents the edge from "blowing out". De-bur the edge with 100-grit sandpaper.

Support Akril Panel back on plywood or MDF sheet or solid work top.

Fig. 5

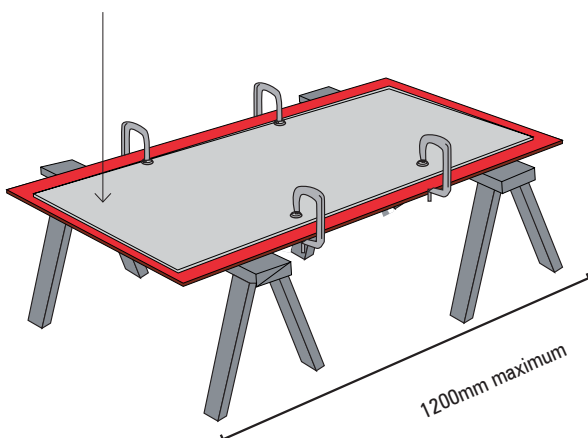

## Drilling Akril with a Blunt Drill Bit

Figure 4

Akril can be drilled using any normal drill bit that is slightly blunt (Figure 4.2). You can blunt a drill bit by first rubbing the tip with a coarse sand paper.

Alternatively you can use a Sutton Multi Purpose drill bit (Figure 4.1) on a slow speed; being particularly careful to reduce the speed as you pass through the other side of your sheet of Akril.

# What Adhesive do I Use?

Akril recommend the use of Fuller HBF660, Bostik V60 neutral cure translucent silicone when sealing and adhering your panels to the wall and sealing between them. Only premium quality neutral cure translucent 100% silicones should be used, this will ensure there is no bleed through the painted finish.

Always follow the adhesive manufacturers instructions when using silicones in wet areas. The use of non recommended or lower quality silicones will void your warranty. Always ensure to test your silicone in an inconspicuous area as silicones can contain fillers that may damage your Akрил panel.

**Figure 1**  
Akril recommends the following procedure when installing your panel behind any cooktop. For areas around your cook top apply a 6mm thick bead of silicone vertically every 100mm the length of the panel. For directly behind your cook top apply 6mm bead of silicone vertically every 20mm the full width to a height of 350mm. When pressing your panel to the wall with your straight edge use enough force to compress the 6mm thick beads of silicone to approximately 2mm.

Note:  
Remember to leave 3mm expansion gap between any adjoining surface & your Polymer panel

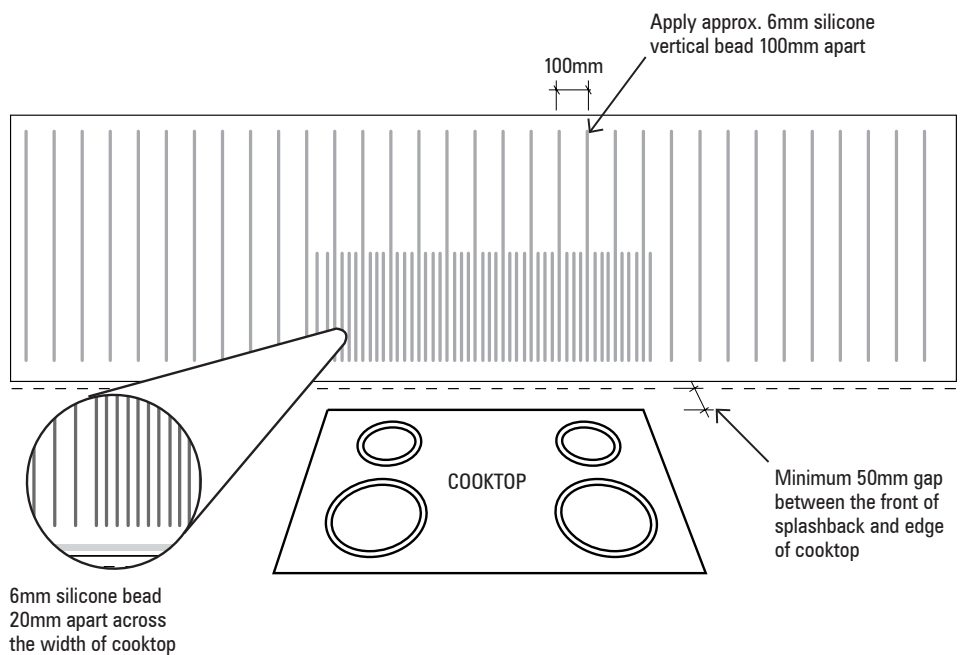
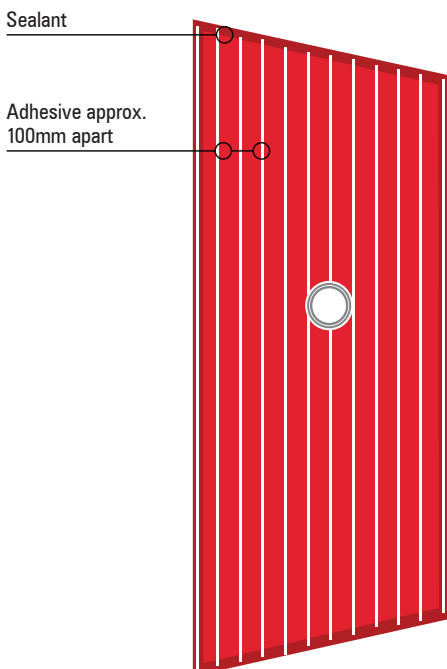

Fig. 1

Fig. 2



## Adhering to the Wall

**Figure 2**  
Each Akрил sheet will expand and contract 3mm into and out of the corner silicone joint.

The first sheet will butt into the wall and allow for 3mm expansion while the second sheet will butt on to the first Akрил sheet allowing for expansion and contraction against the first Akрил sheet which was installed. This will reduce the visible joint line to 3mm instead of 6mm.

**Tip:**  
The use of small pieces of double sided tape can assist in holding your panel in place while the silicone cures.

When laying your Akрил panel to your wall with the use of your straight edge (figure 3) ensure sufficient force is used to reduce the gap between the panel and your wall to a maximum 2mm. This will ensure correct adhesion of your panel to the wall with your neutral cure silicone. Failure to do so could result in insufficient adhesion of your Akрил panel to your wall and void your warranty.

Fig. 3

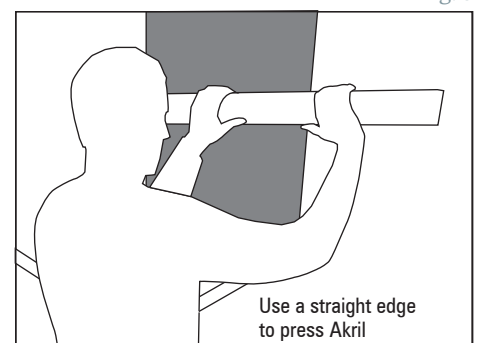

# Joining Sheets Together

## Silicone Join

### General Silicone System

Silicone jointing systems are acceptable for use in both wet and dry areas. In all instances standard glazing industry silicone jointing practices must be followed. Use only neutral cure silicone when joining Akрил.\*

\* Akрил warranty does not cover adhesion of your silicone or damage that can be caused by its use. Seek manufacturers advice where required.

- Internal Corner
- External Corner
- Edge Cap  
*—Supplied by aluminum supplier*
- Butt Join
- Internal Mitred Corner
- External Standoff
- Internal Standoff
- External Mitred
- External Butt

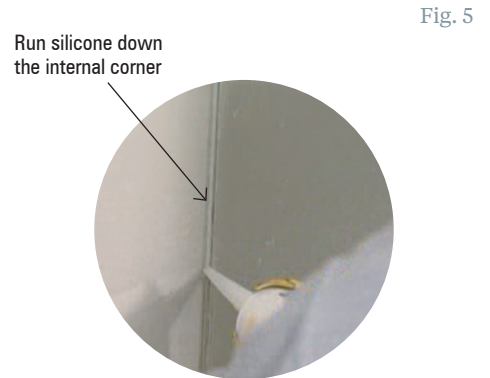
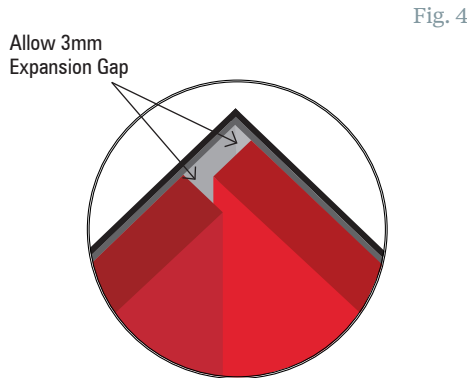

### Sealing the Internal Corner

Akрил suggest in accordance with water proofing standards a neutral cure silicone bead is run from the top of the Akрил down the internal corner (figure 5) to the bottom of the shower base to seal the panel. This is to prevent any moisture penetrating down behind the lining.

Special attention should be paid to the top and bottom of the internal corner and anti-fracture membrane areas.

This document is a guideline for installing Akрил and will not wear any liability for waterproofing. Always install to local and national waterproofing standards. Seek waterproofing companies advice for meeting these standards.

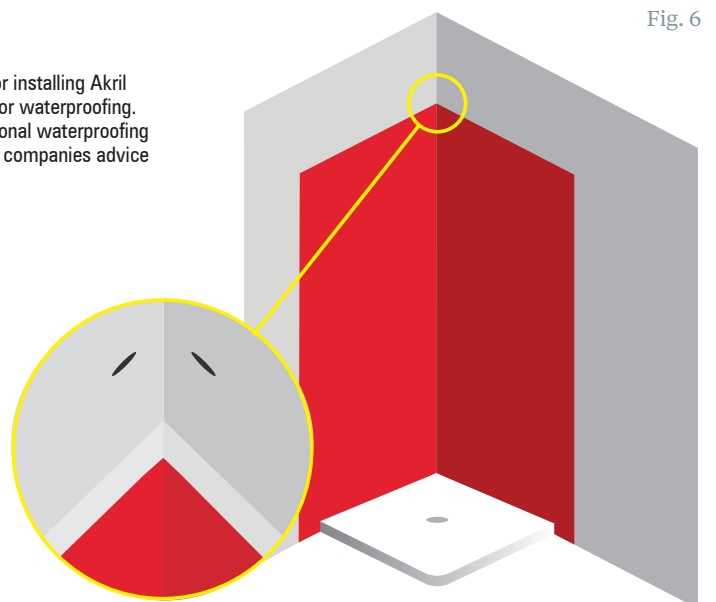

Note: The waterproofing system for your bathroom or shower must meet specific Australia standard building regulations.

**What Adhesive do I Use?**

—Continued

**Taps and Shower Fittings**

Peel back protective film from front face of Akрил, to 25mm beyond the outer edge of the tap spindle installed perimeter.

Apply a bead of recommended neutral cure clear silicone around the perimeter and a second bead around the cut out in your Akрил panel.

Both beads should be finished as per the example in figure 1 leaving a break at the bottom of the bead allowing for condensation or moisture drainage.

Fix tap spindle as per manufacturer’s instructions.

Fig. 1

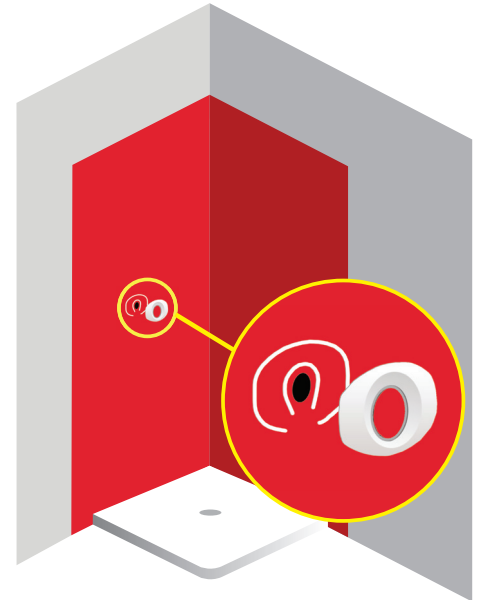

**Butting More Than 2 Sheets Together**

Measure and cut Akрил Panel to size and geometry required. De-bur all edges.

Remove protective film from the rear of panel.

Apply adhesive to specification.

Install leading edge allowing 3mm expansion?

Press panel firmly with your straight edge ensuring to compress your silicone bead to the 2mm spacing between sheet and your wall allowing correct adhesion.

Ensure panel is a good fit onto the wall.

Clean up any adhesive that spills out onto the wall.

Fig. 2

3mm spacing between sheets

3mm spacing between sheets

Note.  
Leave protective film on front of panel until installation is complete.





# Bathroom Installation

## Sealing Edges, Perimeters and Cut Outs

Figure 3

It is important to protect the rear (coated) side of Akril from moisture. Akril needs to be sealed with a band of neutral cure silicone extending 50mm from the edge of the panel.

This should include:	The perimeter of the sheet including any cut outs made
	Perimeter of any penetrations made I.e. tap holes
	The edges of these cut outs

## Installing Akril into a Shower Tray

Figure 4

Acrylic shower trays are commonly installed using the system detailed below.

Acrylic tray should be mounted up to the bottom plate of wall in accordance with the manufacturer's installation instructions.

A manufacture's recommended water proof board should be laid against framing following manufacturer's instructions, down to within 6mm of shower tray.

A neutral cure clear silicone should be installed between top of tray and bottom edge of wall lining as a bond break in a continuous bead, then smoothed off as illustrated.

Fig. 3

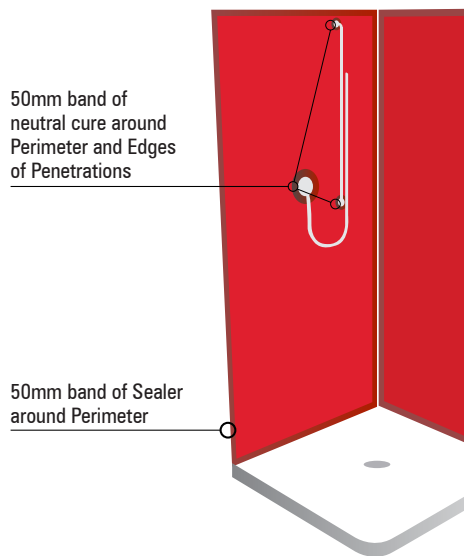
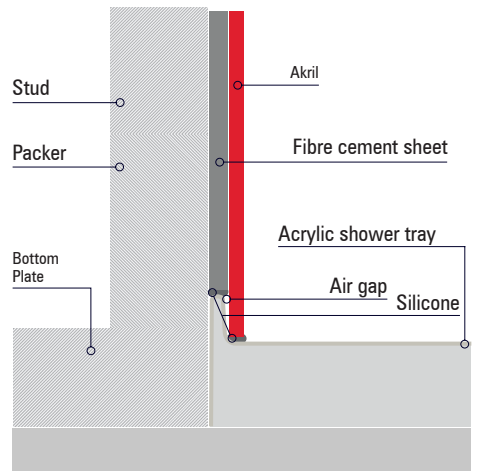
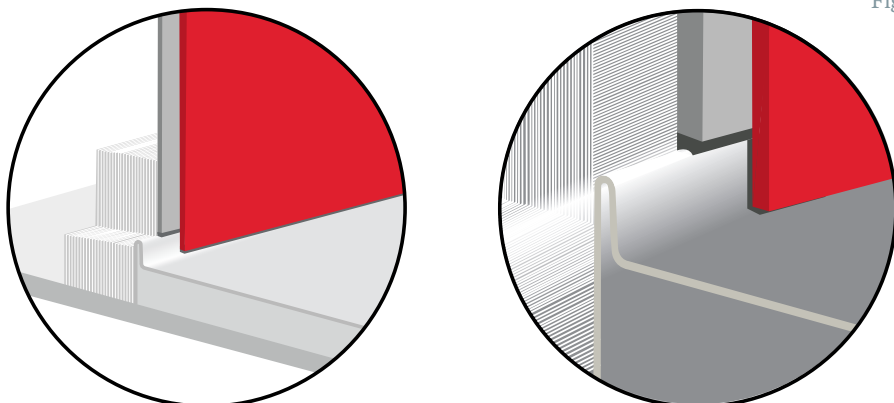

Fig. 4



Note: The waterproofing system for your bathroom or shower must meet specific Australian standard building regulations.

Fig. 5



Akril is then installed over the wall lining and over the up-stand lip of the tray, as illustrated above with a bead of flexible caulking between the back of Akril and front of tray up-stand lip, and the top of tray and bottom edge of Akril.

A gap should be left between the two caulking beads to act as a capillary break.

# Pre-drilling Screw Holes

## *Shower frame*

Do not screw directly into Akрил as it may cause the Akрил sheet to split. All holes must be pre drilled where fixing through Akрил into a wall. You cannot fix anything directly into Akрил panels.

Peel back protective film from front face of Akрил, to the width of door return +25mm from the outer edge of Akрил.

Fit door returns in place ensuring they are in the correct position and plumb.

Drill clearance holes through Akрил and wall linings using a blunt drill bit outlined in detail for machining Akрил.

---

A minimum of 3 fixing points should be used in a 1.8m high shower.

---

A minimum of 4 fixing points should be used in a 2m high shower.

---

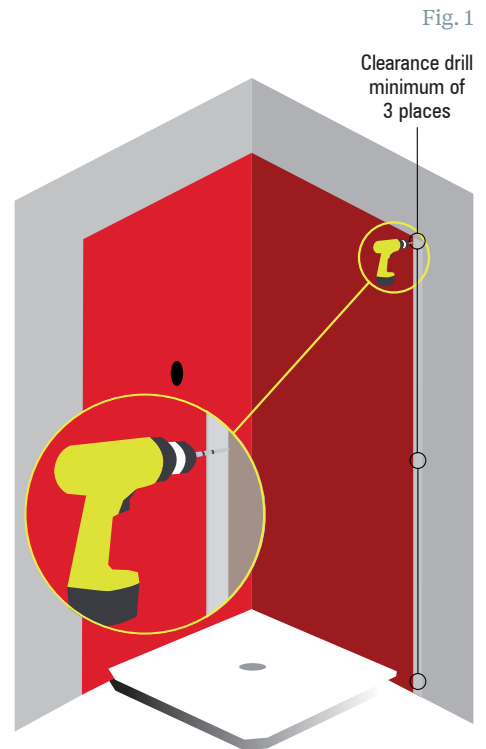

# Installing the Internal Corner & Adhere Sheet

Remove the protective film from rear of Akрил.

Seal the perimeter and all penetrations and penetration edges with a band of neutral cure silicon or acrylic sealant extending 50mm from the edge of the panel as illustrated,above.

Apply adhesive to rear of Akрил as shown in the illustration,above.

Apply a bead of neutral cure clear silicone to the upstand lip of tray.

Apply a bead of neutral cure clear silicone along the full height of the corner onto the liner at the edge of the anti-fracture membrane

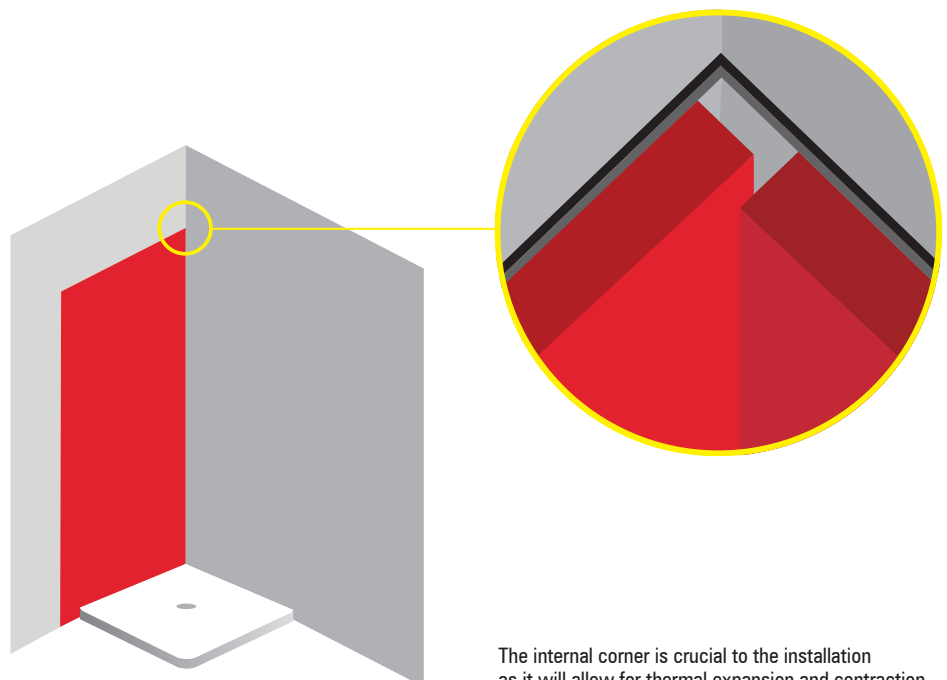

The internal corner is crucial to the installation as it will allow for thermal expansion and contraction.

# Sealing the Internal Corner

Akril suggest in accordance with water proofing standards a neutral cure silicone bead is run from the top of the Akril down the internal corner to the bottom of the shower base to seal the panel. This is to prevent any moisture penetrating down behind the lining.



Note: Run Silicone down internal corner for water proofing.

Special attention should be paid to the top and bottom of the internal corner and anti-fracture membrane areas.

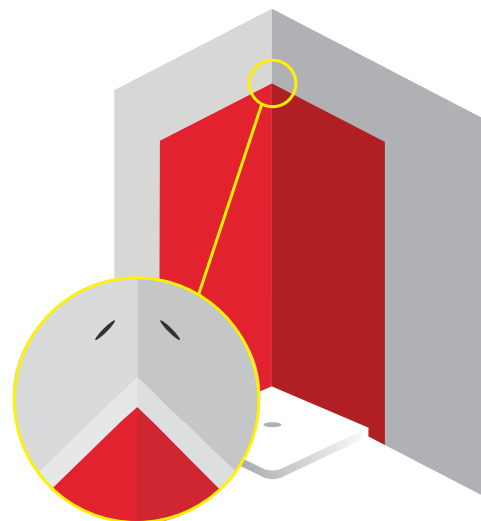

Note: The waterproofing system for your bathroom or shower must meet specific Australian standard building regulations.

# Fitting the Showerscreen & Utilities

Fit the Shower screen to manufacture's specification.

If the installer is required to fit any extra utilities or fittings to the Akril panel be sure to follow the steps listed in this document where machining or cutting is required.

This document is a guideline for installing Akril and will not wear any liability for waterproofing which should be installed to the current Australian Standard.

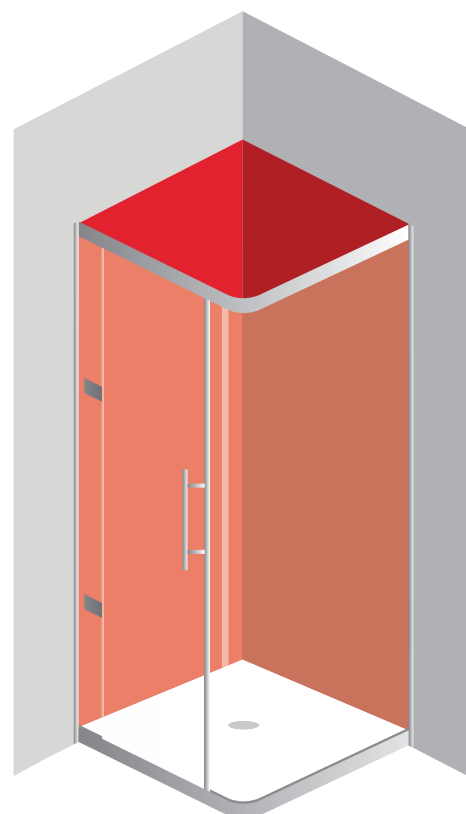

# Shower Frames

Fit door returns back in place.

Fill holes with neutral cure clear silicone before screwing to the wall.

Check for plumb and position before final tightening of door return fastenings.

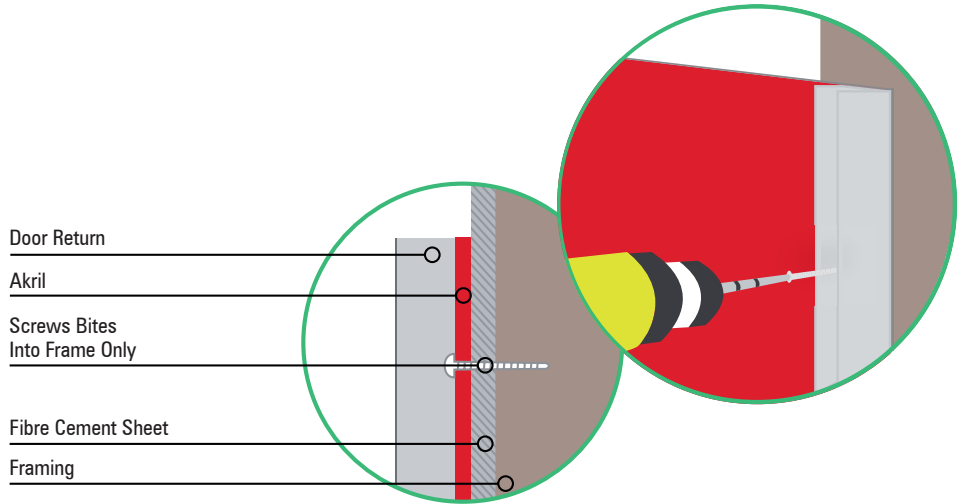

# Installing Internal & External Corners

Remove backing paper.

Ensure there is an expansion gap of 3mm.

Apply silicone to the perimeter of the panel to ensure correct adhesion of panel edges for a smooth finish between sheets

Press the face of the panel with a straight edge for surface adhesion with wall.

The internal and external corners are crucial to the installation as it will allow for thermal expansion and contraction.

Each AkriL sheet will expand and contract 3mm into and out of the corner silicone joint.

The first sheet will butt into the wall and allow for 3mm expansion while the second sheet will butt onto the first AkriL sheet allowing for expansion and contraction against the first AkriL sheet which was installed. This will reduce the visible joint line to 3mm instead of 6mm.

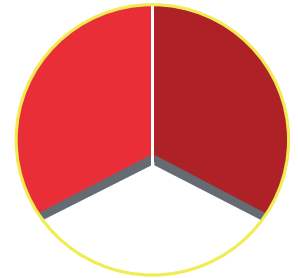
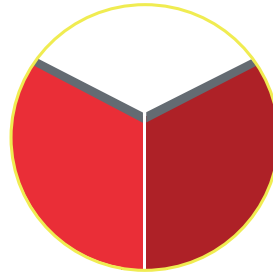

3MM EXPANSION GAP

## Removing Protective Film

Akril is supplied with protective film on both sides:

**Recycled Sticker:** Akril is also supplied with a recycled sticker number 7, which should be left on the Akril for its recycled life after use.

**Painted Side:** has a plastic film designed for protection of the painted surface. Remove this film when all machining operations are complete and the panel is ready to be adhered to the wall/surface.

**Exposed Side:** has a clear plastic film designed for protection against scratches.

Remove the film completely at the very last stage by gently peeling down the sheet surface – never peel at right angles to the sheet as this may pull the sheet away from the installed wall/surface.

Never attempt to cut the protective films with a knife as this may scratch the surface.

## Finishing the Edge After Cutting

If the Akril edge is to be left exposed, it can be easily finished to a polished glass-like quality. A good finish left from the machining process will take considerably less time to finish.

Always peel back the protective film 25mm from the edge while polishing. Remove any sanding dust between grades and polishing compounds immediately.

You can use the Akril polish kit to achieve perfectly polished edges.

### HAND FINISHING

1. Use an 800 grit wet and dry sandpaper to remove any cutter marks from the machined edge.
2. Chamfer any burrs or marks from the corners.
3. Using a soft, clean cloth and a suitable polishing compound, hand rub the edge to a polished finish.

### FLAME POLISHING

A well-machined edge can be flame polished using a Hydrogen/Oxygen mix.

Contact an Acrylic fabricator for this service. An experienced operator can achieve an excellent finish.

# Repair & Maintenance

**Note:**  
Only scratches on the front (non painted) side of your panel can be repaired. If you scratch the painted side (rear) of your panel a colour matched paint will need to be sourced to cover the scratch.

Finer scratches can simply be buffed out of your Akрил splashback using an electric variable speed polisher with a lambs wool or 3000 grit foam pad and cutting compound.

We recommend the use of Juice car polish and cutting compounds. “ Juice Q Cut” compound is the perfect general purpose cutting compound to remove ultra fine scratches and blemishes.

Deeper scratches will require more care and the use of wet and dry sandpapers in conjunction with an electric variable speed polisher to bring your panel back to its original luster.

## **Fine scratches**

Apply your cutting compound directly to the area of your Akрил panel that needs to be repaired. Then apply further compound directly to the polishing pad on your polisher. With your polisher set to a medium speed (1200–1800rpm) rotate the polishing pad in a circular motion until most of the compound is gone and your scratch is removed. Take care not to polish away compound totally as an unlubricated polishing pad will damage your panel. You may need to repeat this step to achieve the best result. Once complete remove any excess compound with a cleaner.

## **Deep scratches**

For deeper scratches the use of wet and dry sandpaper may be required before polishing. When sanding out deeper scratches the use of a hard sanding block is required as this will prevent deep channels from being created by the use of a finger sanding. Use 1200 grit wet and dry sand paper and continuously lubricate the wet and dry sandpaper with water while sanding. Once you have removed the scratch then you are required to polish the area in the same way you polish fine scratches. This will ensure you have a gloss finish to match the rest of your panel.

At times you may need to re polish a larger area than is damaged by your scratch to give an even finish. Often deep scratches may require the use of progressive grades of sand paper to achieve the best result. If you do not succeed in removing the scratch the first time then you will need to progressively attack the scratch using a course, medium to fine wet and dry sandpapers then polish. While this will require extra time you will be able to achieve a required result.

We recommend the use of the Akрил polish kit to help remove all fine to deep scratches from your polymer panels.

---

Freecall Akril  
1800 46 47 28

—  
*[www.akril.com.au](http://www.akril.com.au)*



