



**NOVER**

**REHAU RAUVOLET**  
**ROLLER SHUTTER**  
STANDARD RANGE

# REHAU RAUVOLET ROLLER SHUTTER



## Rauvolet range

Elegance and functionality for your storage.

Discover the perfect blend of form and function with REHAU RAUVOLET tambour door systems, a smart solution for modern interiors. Designed to maximise space and streamline aesthetics, RAUVOLET systems offer smooth, vertical or horizontal opening options that eliminate the need for swing clearance, making them ideal for compact or high-traffic areas.

RAUVOLET roller shutter systems contribute to the Green Star Rating System by the Green Building Council of Australia (GBCA). Green Star is Australia's first comprehensive rating system devised to evaluate the environmental design and performance of buildings, and to drive the adoption of green building practices through market-based solutions.

### CONTENTS:

<b>Range Overview</b>	<b>03</b>
<b>Vertical Applications</b>	<b>04</b>
E9 Noble Matt	05
Metallic Line 25	07
<b>Horizontal and Vertical Applications</b>	<b>09</b>
E9 Noble Matt	10
Metallic Line 25	12
E23 Metallic Silver	14
SE16 Slat Profile	16
<b>Steel Cabinet Applications</b>	<b>18</b>

# REHAU RAUVOLET ROLLER SHUTTER

## RANGE OVERVIEW

The roller shutter stock range offers a flexible selection of tambour door systems, perfectly suited for custom cabinetry across various applications. Focused on design freedom and functional performance, RAUVOLET makes it easy to create tailored, space-efficient solutions.







## SYSTEM OPTIONS

### 1. Vertical applications with counterweight mechanism

Upgrade your cabinetry with a premium roller shutter system featuring the FRAME front mounted track system and innovative C3 counterweight mechanism. Designed for smooth, effortless operation and a sleek finish, this system is ideal for larger openings and can be retrofitted into existing cabinets.

### 2. Horizontal and vertical applications with recessed tracks

For maximum versatility, choose from 8mm or 12mm systems with recessed tracks and accessories to suit your layout. Whether mounted to the rear wall, side wall, or configured for up-and-over use, this system adapts to a wide range of vertical or horizontal applications.

Application Type	Vertical Counter Balanced	Vertical Up and Over		Horizontal Straight Track		Horizontal Flexible Track
Track system	FRAME	CLASSIC	FLEXIBLE	CLASSIC		FLEXIBLE
	Front Mounted	Recessed				
Track Layout	Up into bale	Up & Over	Up & Over	Side Wall	Rear Wall	Rear Wall
						
<b>E9 Noble Matt</b>	■	■ (8mm)	■	■ (8mm)	■ (8mm)	■
<b>ML25 Metallic Line</b>	■	■ (8mm)	■	■ (8mm)	■ (8mm)	■
<b>E23</b>		■ (8mm)	■	■ (8mm)	■ (8mm)	■
<b>SE16</b>		■ (12mm)		■ (12mm)	■ (12mm)	

For cabinet size guidelines, refer to the Roller Shutter Fabrication Guide and Estimator forms.





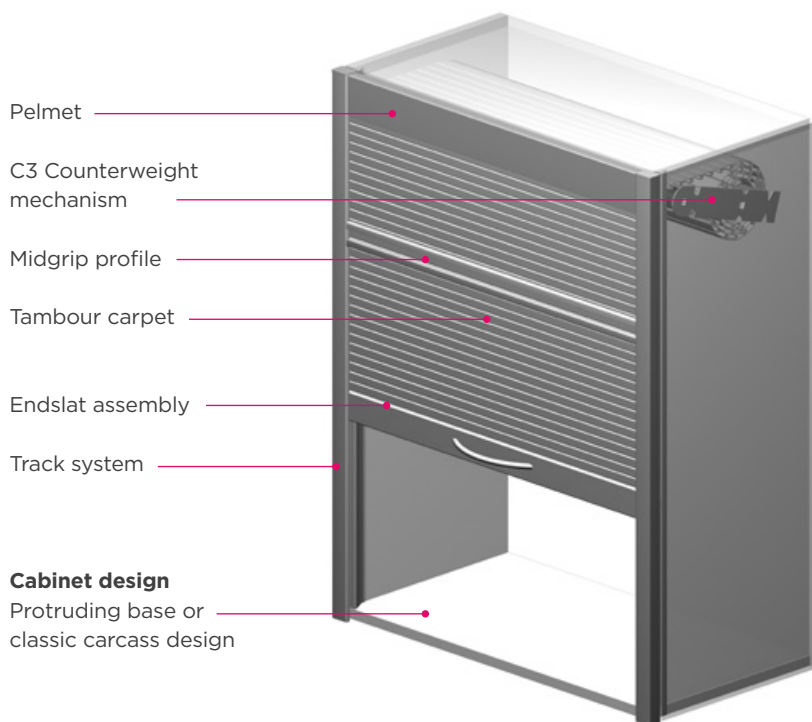





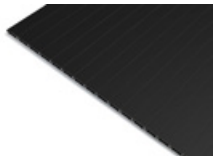
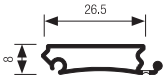
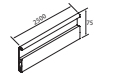
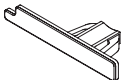
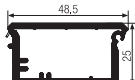



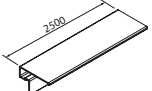
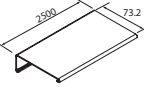
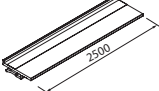

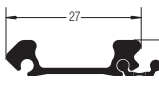
# VERTICAL APPLICATIONS FRONT MOUNTED TRACK SYSTEM

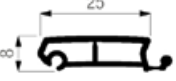
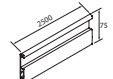
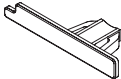

## Complete system for vertical use:

- Front mounted tracks
- Can be retrofitted to existing cabinet
- Smooth running properties
- Optimum counter-balance with high-quality sprung core mechanism
- Colour matched accessories (tracks, pelmet, Endslat)
- Large application range
  - Height: 650-2200mm
  - Width: 600-1200mm

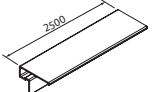
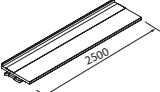
	Standard Option		Lockable Option			
DOOR SLAT PROFILE	Combination Endslat	Endslat sliders	Flush fit Endslat	Flush fit Endslat sliders	PP Frame Tracks	End Caps
<b>E9 NOBLE MATT(PP):</b>   R709925-065	 R710528-065	 R710545-001	 R708399-065	 R793019-001	 R710519-065	 R710524-065
	<b>Alu. Pelmet Base</b>  R710499-001	<b>Pelmet Cover</b>  R710498-065	<b>Mounting Profile</b>  R793079-001	<b>C3 Mechanism</b>  R7798X0-001	<b>Mid Grip</b>  R709642-065	

DOOR SLAT PROFILE	Combination Endslat	Endslat sliders	Alu. Frame tracks	Track covers	End Caps	Inlet guides
<b>METALLIC LINE 25</b>   R786065-003	 R793007-002	 R779914-001	 R779550-002	 R779560-002	 R779630-005	 R793010-001
	<b>Pelmet</b>  R708761-002	<b>Mounting Profile</b>  R793079-001	<b>C3 Mechanism</b>  R7798X0-001			

# VERTICAL APPLICATIONS

## SURFACE MOUNT TRACK SYSTEM

### E9 Noble Matt

Beauty that you can feel. RAUVOLET Noble Matt not only impresses with its matt appearance, even at low angles, but its anti-fingerprint surfaces and soft touch finish also make it ideal for daily use. Of course, it always offers the customary REHAU quality and smooth operation.

#### FEATURES:

- Anti-fingerprint
- Soft touch
- High scratch resistance
- Modern aesthetic
- Matt finish



DESCRIPTION	CODE	UOM
SLAT E9 NOBLE MATT 2500MM AFTER DARK	R709925-065	LENGTH

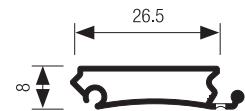

DESCRIPTION	CODE	UOM
ENDSLAT COMBI E9 NOBLE MATT PP/ALU 2500MM AFTER DARK	R710528-065	LENGTH

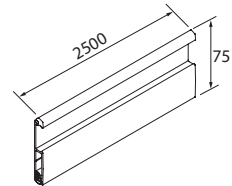

DESCRIPTION	CODE	UOM
ENDSLAT COMBI SLIDERS E9 NOBLE MATT	R710545-001	SET

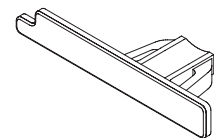

DESCRIPTION	CODE	UOM
ENDSLAT FLUSH-FIT E9 NOBLE MATT AFTER DARK 2500MM	R708399-065	LENGTH



DESCRIPTION	CODE	UOM
ENDSLAT FLUSH-FIT SLIDER E9 NOBLE MATT 8MM	R793019-001	PAIR

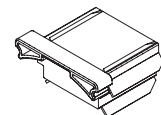

DESCRIPTION	CODE	UOM
MIDGRIP HANDLE PROFILE E9 NOBLE MATT 2500MM AFTER DARK	R709642-065	LENGTH

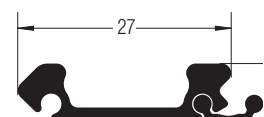

# VERTICAL APPLICATIONS

## FRONT MOUNTED TRACK SYSTEM

DESCRIPTION	CODE	UOM
PELMET VERTICAL BASE E9 NOBLE MATT ALU 2500MM	R710499-001	LENGTH

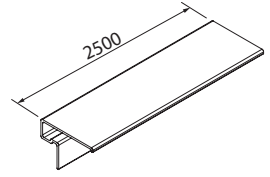

DESCRIPTION	CODE	UOM
PELMET VERTICAL COVER E9 NOBLE MATT 2500MM AFTER DARK	R710498-065	LENGTH

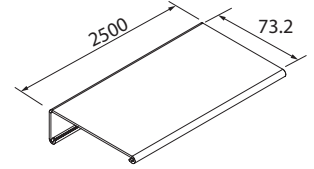

DESCRIPTION	CODE	UOM
PELMET MOUNTING PROFILE E9/ML25 2500MM	R793079-001	LENGTH

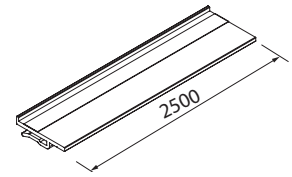

DESCRIPTION	CODE	UOM
VERTICAL RUNNING TRACK E9 NOBLE MATT 2300MM AFTER DARK	R710519-065	LENGTH

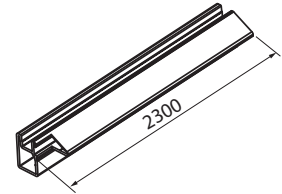

DESCRIPTION	CODE	UOM
TRACK END CAPS E9 NOBLE MATT AFTER DARK	R710524-065	PIECE

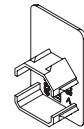

DESCRIPTION	CODE	ROLL
ADHESIVE TAPE	R793039-001	50M

\* The adhesive tape is applied to the reverse side of the tambour door to ensure better handling and assist in assembly of the cabinet.



DESCRIPTION	CODE	UOM
REHAU LOCK TO SUIT NOBLE MATT PROFILE	R700695-001	SET

\* Lock set can only be used with Flush-Fit Endslat R708399-065

\* R700695-001 includes housing and cylinder core key



DESCRIPTION	CODE	UOM
C3 BALANCING MECHANISM 600MM	R779840-001	EACH
C3 BALANCING MECHANISM 800MM	R779850-001	EACH
C3 BALANCING MECHANISM 1000MM	R779860-001	EACH
C3 BALANCING MECHANISM 1200MM	R779870-001	EACH
C3 EXTENSION 165MM	R779320-002	EACH

\* Refer to C3 Fabrication Guide for applicable cabinet dimensions



# VERTICAL APPLICATIONS

## FRONT MOUNTED TRACK SYSTEM

### Metallic Line 25 Brushed Stainless Steel

This RAUVOLET metallic-line tambour door system combines the premium feel of stainless steel with the comfort, convenience and practicality of polymer tambour door systems.

#### FEATURES:

- Stylish Stainless Steel finish
- High quality finish
- Modern aesthetic

**Note:** Item not lockable



DESCRIPTION	CODE	UOM
METALLIC LINE 25MM SLAT 2500MM BR S/STEEL	R786065-003	LENGTH

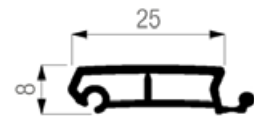

DESCRIPTION	CODE	UOM
ENDSLAT COMBI ML25 2500MM BR S/STEEL	R793007-002	LENGTH

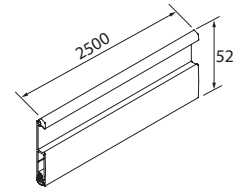

DESCRIPTION	CODE	UOM
ENDSLAT COMBI SLIDER ML25	R779914-001	SET

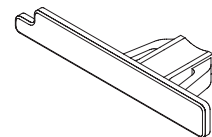

DESCRIPTION	CODE	UOM
PELMET VERTICAL ML25 2500MM BR S/STEEL	R708761-002	LENGTH

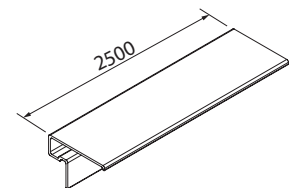

DESCRIPTION	CODE	UOM
PELMET MOUNTING PROFILE E9/ML25 2500MM	R793079-001	LENGTH

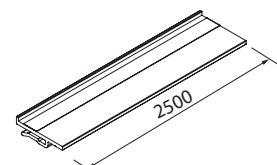

DESCRIPTION	CODE	UOM
FRAME RUNNING TRACK FRONT MOUNT ML25 2500MM	R779550-002	LENGTH

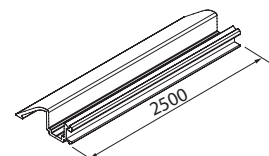

# VERTICAL APPLICATIONS

## FRONT MOUNTED TRACK SYSTEM

DESCRIPTION	CODE	UOM
FRAME TRACK COVER ML25 2500MM BR S/STEEL	R779560-002	LENGTH

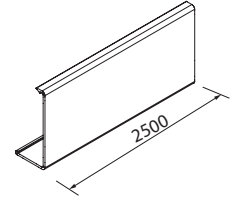

DESCRIPTION	CODE	UOM
FRAME END CAPS ML25 ALUMINIUM DÉCOR	R779630-005	PAIR

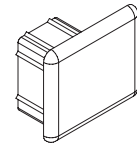

DESCRIPTION	CODE	UOM
FRAME INLET GUIDE ML25	R793010-001	SET

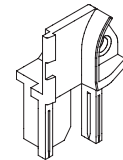

DESCRIPTION	CODE	ROLL
ADHESIVE TAPE	R793039-001	50M

\* The adhesive tape is applied to the reverse side of the tambour door to ensure better handling and assist in assembly of the cabinet.



DESCRIPTION	CODE	UOM
C3 BALANCING MECHANISM 600MM	R779840-001	EACH
C3 BALANCING MECHANISM 800MM	R779850-001	EACH
C3 BALANCING MECHANISM 1000MM	R779860-001	EACH
C3 BALANCING MECHANISM 1200MM	R779870-001	EACH
C3 EXTENSION 165MM	R779320-002	EACH

\* Refer to C3 Fabrication Guide for applicable cabinet dimensions



# HORIZONTAL AND VERTICAL APPLICATIONS RECESSED TRACK SYSTEMS

## Complete systems for horizontal and vertical use:

- Recessed Tracks for timber panels
- Smooth running properties
- Versatile installation options
- Colour matched accessories (tracks, pelmet, endslat)

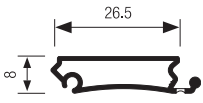
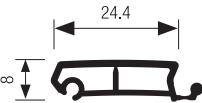
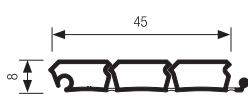
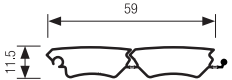

## RECESSED TRACK APPLICATIONS

	8mm Systems			12mm Systems
<b>Slats</b>	<b>E9 Noble Matt (PP):</b> After Dark  	<b>ML25 Metallic Line:</b> Brushed Stainless Steel  	<b>E23 (PVC):</b> Metallic Silver  	<b>SE16 (PVC):</b> Metallic Silver Charcoal White  
<b>Endslat</b>	Flush-Fit Endslat + Flush-Fit Sliders or Combi Endslat PP + Combi Endslat Sliders	Combi Endslat Alu. + Combi Endslat Sliders	Alu. Endslat + Endslat Cover + Endslat Sliders + Recessed Handle*	
<b>Pelmet</b>	PP Pelmet	Not available	PVC Pelmet	
<b>Track</b>	Classic Straight 8mm or Flexible 8mm**			Classic Straight 12mm
<b>Classic Track Accessories</b>	2-Way Spiral, 4-Way Spiral, 90 Degree Corners			2-Way Spiral, 4-Way Spiral, 90 Degree Corners
<b>Double Door Accessories</b>	Not available		Endslat Adaptor, Magnetic Strip, Centre Stopper	

\* Optional

\*\* Flexible track used on it's own (no corners or spirals)

### CLASSIC SPIRAL

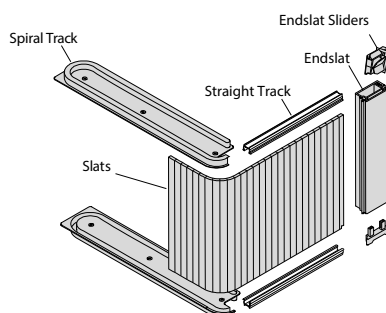

### CLASSIC 90°

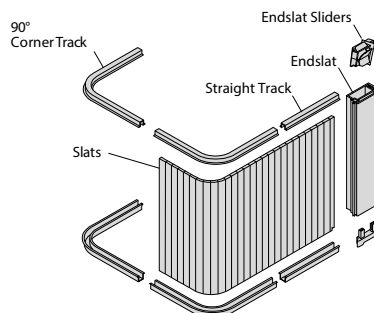

### CLASSIC FLEXIBLE

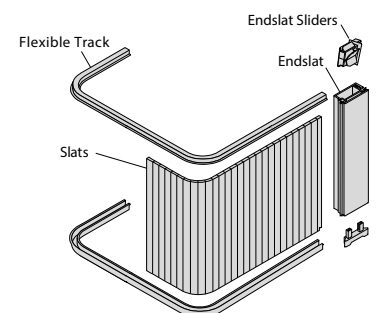

For vertical applications, illustration is simply rotated 90 degrees to reflect the orientation.

# HORIZONTAL AND VERTICAL APPLICATIONS

## RECESSED TRACK SYSTEMS E9 - 8MM

### E9 Noble Matt

Beauty that you can feel. RAUVOLET noble matt not only impresses with its matt appearance, even at low angles, but its anti-fingerprint surfaces and soft touch finish also make it ideal for daily use. Of course, it always offers the customary REHAU quality and smooth operation.

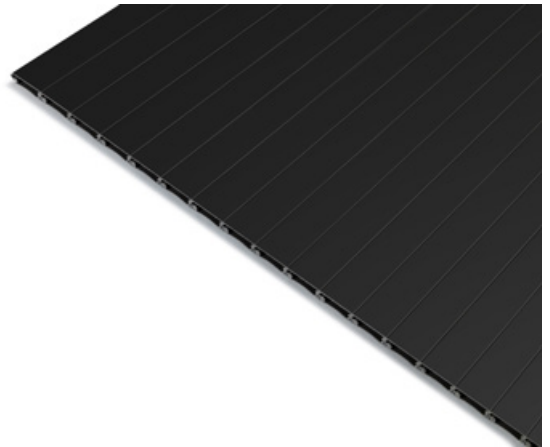

#### FEATURES:

- Anti-fingerprint
- Soft touch
- High scratch resistance
- Modern aesthetic
- Matt finish

DESCRIPTION	CODE	UOM
SLAT E9 NOBLE MATT 2500MM AFTER DARK	R709925-065	LENGTH

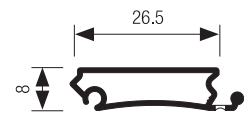

DESCRIPTION	CODE	UOM
ENDSLAT FLUSH-FIT E9 NOBLE MATT 2500MM AFTER DARK	R708399-065	LENGTH

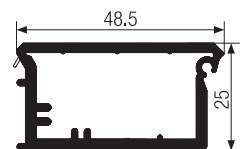

DESCRIPTION	CODE	UOM
ENDSLAT FLUSH-FIT SLIDER E9 NOBLE MATT	R793019-001	PAIR

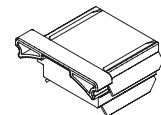

DESCRIPTION	CODE	UOM
ENDSLAT COMBI E9 NOBLE MATT PP/ALU 2500MM AFTER DARK	R710528-065	LENGTH

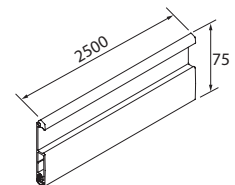

DESCRIPTION	CODE	UOM
ENDSLAT COMBI SLIDERS E9 NOBLE MATT	R710545-001	SET

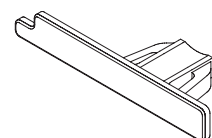

DESCRIPTION	CODE	UOM
MIDGRIP HANDLE PROFILE E9 NOBLE MATT 2500MM AFTER DARK	R709642-065	LENGTH



# HORIZONTAL AND VERTICAL APPLICATIONS

## RECESSED TRACK SYSTEMS E9 - 8MM

DESCRIPTION	CODE	UOM
PELMET E9 NOBLE MATT 2500MM AFTER DARK	R708407-065	LENGTH

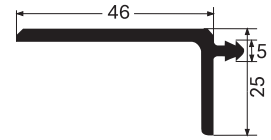

DESCRIPTION	CODE	UOM
FLEXIBLE TRACK 8MM E9/E23/ML25 2500MM	R779300-001	LENGTH

\* Minimum inner radius  $r_i = 35.5$  mm

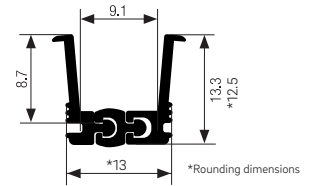

DESCRIPTION	CODE	UOM
CLASSIC STRAIGHT TRACK 8MM E9/E23/ML25 2500MM	R770383-070	LENGTH

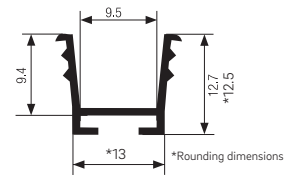

DESCRIPTION	CODE	UOM
TRACK 90 DEGREE CORNER TCAB E9/E23/ML25 8MM PA	R779690-001	EACH

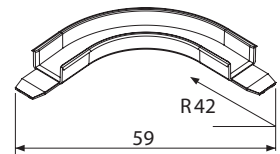

DESCRIPTION	CODE	UOM
SPIRAL TRACK 2 WAY E9/E23/ML25 PA 8MM	R779730-001	SET
SPIRAL TRACK 4 WAY E9/E23/ML25 PA 8MM	R779750-001	SET

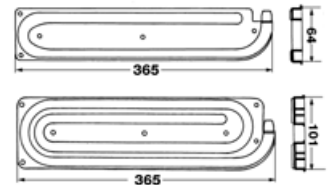

DESCRIPTION	CODE	UOM
STOPPER TCAB RECESSED E9/E23/ML25 8MM	R779710-001	EACH

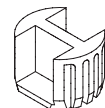

DESCRIPTION	CODE	ROLL
ADHESIVE TAPE	R793039-001	50M

\* The adhesive tape is applied to the reverse side of the tambour door to ensure better handling and assist in assembly of the cabinet.



DESCRIPTION	CODE	UOM
REHAU LOCK TO SUIT NOBLE MATT PROFILE	R700695-001	SET

\* Lock set can only be used with Flush-Fit Endsplat R708399-065  
 \* R700695-001 includes housing and cylinder core key



# HORIZONTAL AND VERTICAL APPLICATIONS

## RECESSED TRACK SYSTEMS ML25 - 8MM

### Metallic Line 25 Brushed Stainless Steel

This RAUVOLET metallic-line tambour door system combines the premium feel of stainless steel with the comfort, convenience and practicality of polymer tambour door systems.



#### FEATURES:

- Stylish Stainless Steel finish
- High quality finish
- Modern aesthetic

Note: Item not lockable

DESCRIPTION	CODE	UOM
METALLIC LINE 25MM SLAT 2500MM BR S/STEEL	R786065-003	LENGTH

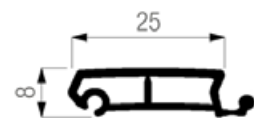

DESCRIPTION	CODE	UOM
ENDSLAT COMBI ML25 2500MM BR S/STEEL	R793007-002	LENGTH

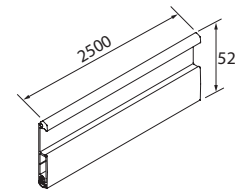

DESCRIPTION	CODE	UOM
ENDSLAT COMBI SLIDER ML25	R779914-001	SET

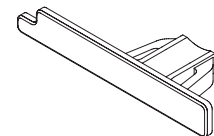

DESCRIPTION	CODE	UOM
FLEXIBLE TRACK 8MM E9/E23/ML25 2500MM	R779300-001	LENGTH

\* Minimum inner radius  $r_i = 35.5$  mm

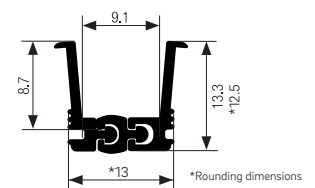

DESCRIPTION	CODE	UOM
CLASSIC STRAIGHT TRACK 8MM E9/E23/ML25 2500MM	R770383-070	LENGTH

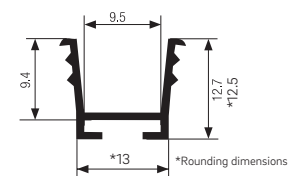

DESCRIPTION	CODE	UOM
TRACK 90 DEGREE CORNER TCAB E9/E23/ML25 8MM PA	R779690-001	PIECE

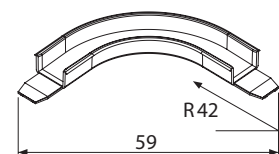

# HORIZONTAL AND VERTICAL APPLICATIONS

## RECESSED TRACK SYSTEMS ML25 - 8MM

DESCRIPTION	CODE	UOM
SPIRAL TRACK 2 WAY E9/E23/ML25 PA 8MM	R779730-001	SET
SPIRAL TRACK 4 WAY E9/E23/ML25 PA 8MM	R779750-001	SET

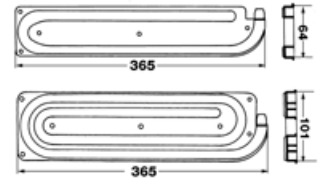

DESCRIPTION	CODE	UOM
STOPPER TCAB RECESSED E9/E23/ML25 8MM	R779710-001	EACH

\* Applicable only to Double Door configurations

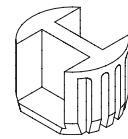

DESCRIPTION	CODE	ROLL
ADHESIVE TAPE	R793039-001	50M

\* The adhesive tape is applied to the reverse side of the tambour door to ensure better handling and assist in assembly of the cabinet.



# HORIZONTAL AND VERTICAL APPLICATIONS

## RECESSED TRACK SYSTEMS E23 - 8MM

### E23 Metallic Silver

The Classic E23 RAUVOLET Slat is a lightweight versatile option that can be used in a large variety of applications. Combine with either Classic 8mm straight track or 8mm Flexible track to suit your application.

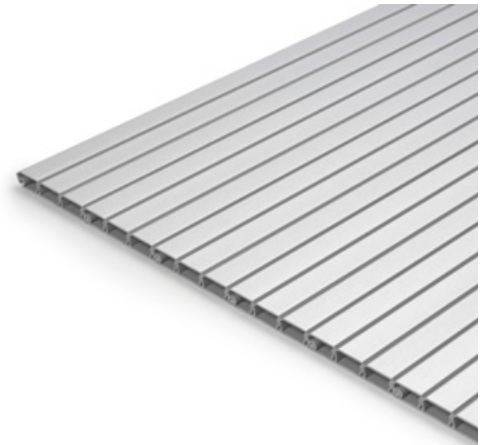

#### Endslat Assembly

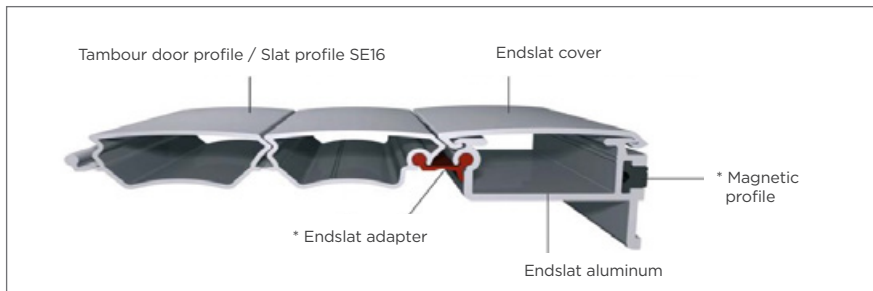

\* Required for double door only

DESCRIPTION	CODE	UOM
SLAT E23 DÉCOR PVC 3900MM METALLIC SILVER	R770106-053	LENGTH

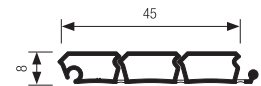

DESCRIPTION	CODE	UOM
ENDSLAT ALUMINIUM SE16/E23 3900MM	R223938-002	LENGTH

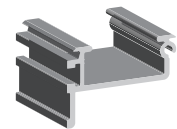

DESCRIPTION	CODE	UOM
ENDSLAT/ SLAM RAIL SLIDERS E23 POM 8MM	R242912-001	PAIR

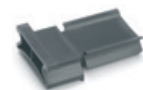

DESCRIPTION	CODE	UOM
ENDSLAT COVER SE16/E23 PVC 3900MM MET SILVER	R770286-286	LENGTH



DESCRIPTION	CODE	UOM
RECESSED HANDLE PA WHITE ALUMINIUM (METALLIC SILVER)	R249791-003	PIECE



DESCRIPTION	CODE	UOM
PELMET SE16/E23 PVC 3900MM METALLIC SILVER	R770175-029	LENGTH



# HORIZONTAL AND VERTICAL APPLICATIONS

## RECESSED TRACK SYSTEMS E23 - 8MM

DESCRIPTION	CODE	UOM
FLEXIBLE TRACK 8MM E9/E23/ML25 2500MM	R779300-001	LENGTH

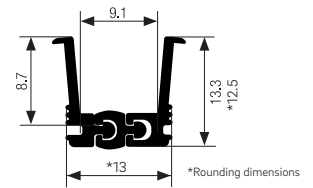

DESCRIPTION	CODE	UOM
CLASSIC STRAIGHT TRACK 8MM E9/E23/ML25 2500MM	R770383-070	LENGTH

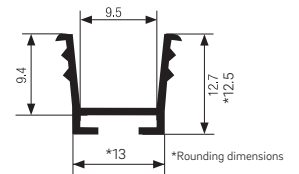

DESCRIPTION	CODE	UOM
TRACK 90 DEGREE CORNER TCAB E9/E23/ML25 8MM PA	R779690-001	EACH

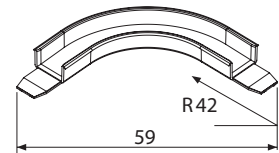

DESCRIPTION	CODE	UOM
SPIRAL TRACK 2 WAY E9/E23/ML25 PA 8MM	R779730-001	SET
SPIRAL TRACK 4 WAY E9/E23/ML25 PA 8MM	R779750-001	SET

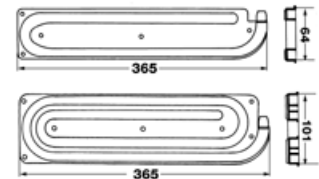

DESCRIPTION	CODE	UOM
STOPPER TCAB RECESSED E9/E23/ML25 8MM	R779710-001	EACH

\* Applicable only to Double Door configurations

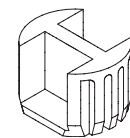

DESCRIPTION	CODE	UOM
MAGNETIC STRIP ENDSLAT SE16/E23 PA	R618974-412-10M	10M
ENDSLAT ADAPTOR SE16/E23 PVC 3900MM	R770296-027	EACH

\* Applicable only to Double Door configurations



DESCRIPTION	CODE	ROLL
ADHESIVE TAPE	R793039-001	50M

\*The adhesive tape is applied to the reverse side of the tambour door to ensure better handling and assist in assembly of the cabinet.



DESCRIPTION	CODE	UOM
TAMBOUR DOOR LOCK-DOUBLE DOORS	552000	EACH
TAMBOUR DOOR LOCK-SINGLE DOORS	552001	EACH
CYLINDER KEYED ALIKE 001	552002	EACH

\* Inquire with branch for additional cylinder options



552000

552001

552002

# HORIZONTAL AND VERTICAL APPLICATIONS

## RECESSED TRACK SYSTEMS SE16 - 12MM

### SE16 Slat Profile

Available in various colours, the robust 12mm slat offers greater stability combined with smooth operation when used with the Classic 12mm straight tracks and accessories.



### Endslat Assembly

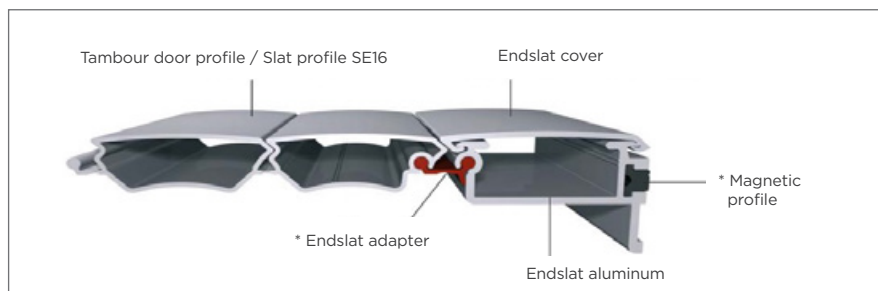

\* Required for double door only

DESCRIPTION	CODE	UOM
SLAT SE16 DECOR PVC 3900MM MET SILVER	R770716-309	LENGTH
SLAT SE16 UNI PVC 3900MM CHARCOAL	R770756-175	LENGTH
SLAT SE16 UNI PVC 3900MM WHITE	R770756-047	LENGTH

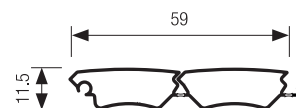

DESCRIPTION	CODE	UOM
ENDSLAT ALUMINIUM SE16/E23 3900MM	R223938-002	LENGTH

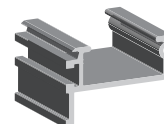

DESCRIPTION	CODE	UOM
ENDSLAT SE16 SLIDERS POM 12MM	R242902-001	PAIR

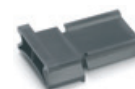

DESCRIPTION	CODE	UOM
ENDSLAT COVER SE16/E23 PVC 3900MM MET SILVER	R770286-286	LENGTH
ENDSLAT COVER SE 16/E23 PVC 3900MM CHARCOAL	R770266-046	LENGTH
ENDSLAT COVER SE16/E23 PVC 3900MM WHITE	R770266-037	LENGTH



DESCRIPTION	CODE	UOM
RECESSED HANDLE PA WHITE ALUMINIUM (METALLIC SILVER)	R249791-003	PIECE
RECESSED HANDLE PA CHARCOAL	R249791-005	PIECE
RECESSED HANDLE PA WHITE	R249791-037	PIECE



DESCRIPTION	CODE	UOM
PELMET SE16/E23 PVC 3900MM METALLIC SILVER	R770175-029	LENGTH
PELMET SE16/E23 PVC 3900MM CHARCOAL	R770165-003	LENGTH
PELMET SE16/E23 PVC 3900MM WHITE	R770165-019	LENGTH



# HORIZONTAL AND VERTICAL APPLICATIONS

## RECESSED TRACK SYSTEMS SE16 - 12MM

DESCRIPTION	CODE	UOM
CLASSIC STRAIGHT TRACK 12MM SE16 2500MM	R612123-203	LENGTH

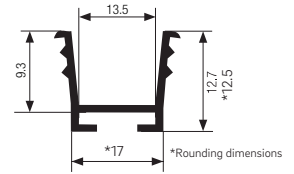

DESCRIPTION	CODE	UOM
TRACK 90 DEGREE CORNER TCAB SE16 12MM PA	R266222-004	EACH

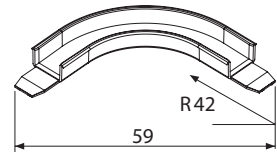

DESCRIPTION	CODE	UOM
SPIRAL TRACK 2 WAY SE16 PA 12MM	R779740-001	SET
SPIRAL TRACK 4 WAY SE16 PA 12MM	R779760-001	SET

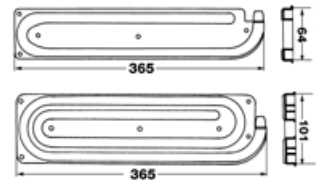

DESCRIPTION	CODE	UOM
STOPPER TCAB SE16 PA 12MM	R248866-001	EACH

\* Applicable only to Double Door configurations

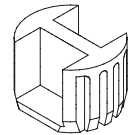

DESCRIPTION	CODE	UOM
MAGNETIC STRIP ENDSLAT SE16/E23 PA 10 MTR	R618974-412-10M	10M
ENDSLAT ADAPTOR SE16/E23 PVC 3900MM	R770296-027	EACH

\* Applicable only to Double Door configurations

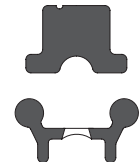

DESCRIPTION	CODE	ROLL
ADHESIVE TAPE	R793039-001	50M

\* The adhesive tape is applied to the reverse side of the tambour door to ensure better handling and assist in assembly of the cabinet.



DESCRIPTION	CODE	UOM
TAMBOUR DOOR LOCK-DOUBLE DOORS	552000	EACH
TAMBOUR DOOR LOCK-SINGLE DOORS	552001	EACH
CYLINDER KEYED ALIKE 001	552002	EACH

\* Inquire with branch for additional cylinder options



# STEEL CABINET APPLICATIONS

## SURFACE MOUNTED TRACK SYSTEM SE16 - 12MM

### Steel Cabinet Options

The one-piece injection moulded spiral track system is compact, easy to fit, and designed for use with RAUVOLET SE16 slats in steel cabinets. It offers smooth operation with minimal space requirements.



#### FEATURES:

- Horizontal applications only
- Double door options available

DESCRIPTION	CODE	UOM
TRACK METAL CABINET RIGHT HAND PP 600MM	R289431-001	EACH

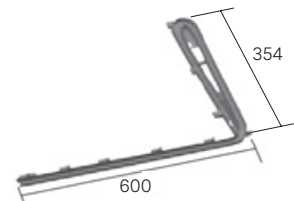

DESCRIPTION	CODE	UOM
TRACK METAL CABINET LEFT HAND PP 600MM	R289427-001	EACH

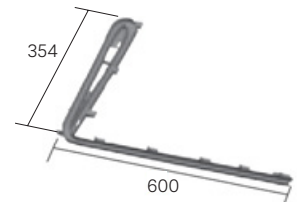

DESCRIPTION	CODE	UOM
STOPPER METAL CAB SURFACE SE16 PA 12MM NO1	R247262-001	EACH

\* Applicable only to Double Door configurations



# CONTACT US

## NSW

### Sydney – Head Office

19 Wonderland Drive,  
Eastern Creek NSW 2766  
P: 1300 668 371  
E: sydney@nover.com.au

### Newcastle

93 Munibung Road,  
Cardiff NSW 2285  
P: (02) 4956 6626  
E: newcastle@nover.com.au

### Orange

38 Leewood Drive,  
Orange NSW 2800  
P: (02) 6362 9666  
E: orange@nover.com.au

### Port Macquarie

40 Jindalee Road,  
Port Macquarie NSW 2444  
P: (02) 6581 2202  
E: portmacquarie@nover.com.au

### Wagga Wagga

1B Wentworth Street,  
Wagga Wagga NSW 2650  
P: (02) 6921 6499  
E: wagga@nover.com.au

### Wollongong

3 Lady Penryhn Drive,  
Unanderra NSW 2526  
P: (02) 4271 3266  
E: wollongong@nover.com.au

## QLD

### Brisbane – Main Office

Unit 4/22  
Eastern Service Road,  
Stapylton QLD 4207  
P: 1300 599 057  
E: brisbane@nover.com.au

### Townsville

Unit 2/5-7 Greg Jabs Drive,  
Garbutt QLD 4814  
P: (07) 4775 3500  
E: townsville@nover.com.au

## ACT

### Fyshwick

Unit 10/145-147  
Gladstone Street,  
Fyshwick ACT 2609  
P: (02) 6299 1100  
E: act@nover.com.au

## VIC

### Melbourne

30 Jersey Road,  
Bayswater VIC 3153  
P: (03) 9729 0666  
E: melbourne@nover.com.au

## FOLLOW US @

 [NoverAustralia](#)  [noveraustralia](#)  [Nover & Co Pty Ltd](#)

# NOVER

NOVER & CO PTY LIMITED  
ABN 15 001 706 038

19 WONDERLAND DRIVE, EASTERN CREEK NSW 2766  
LOCKED BAG 90, WETHERILL PARK BUSINESS CENTRE NSW 1851

T 1300 668 371 F 1300 668 372 E info@nover.com.au

[www.nover.com.au](http://www.nover.com.au)



REHAU RAUVOLET BROCHURE 2026